

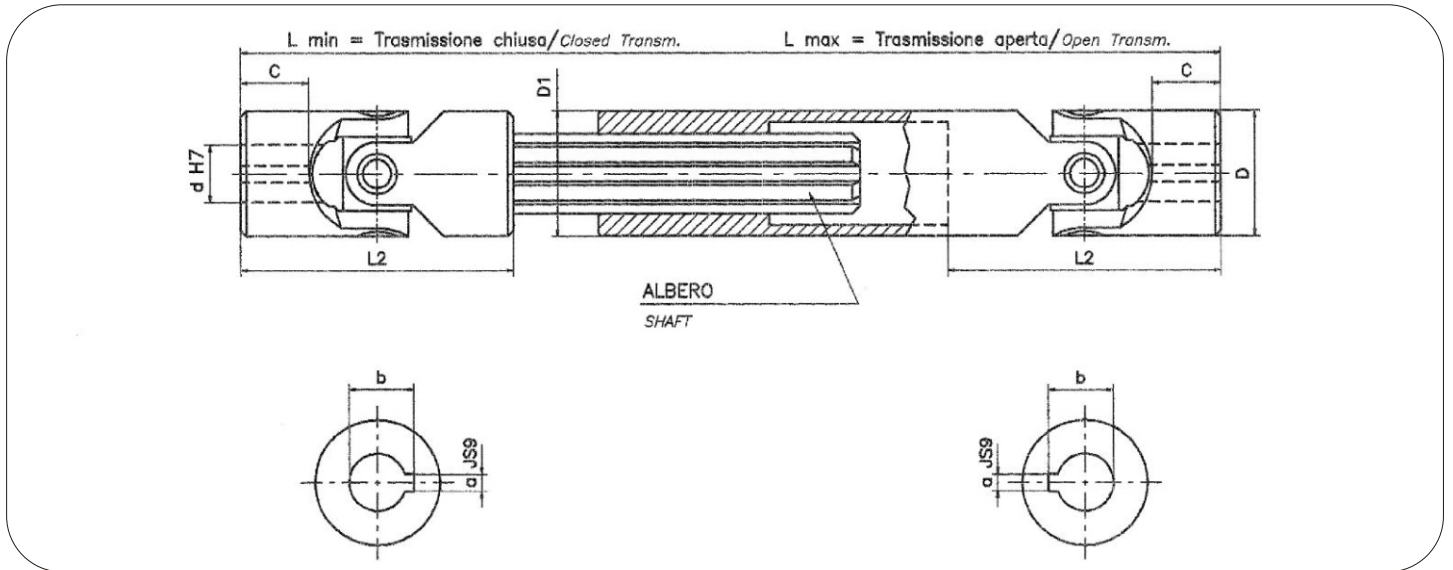

TRASMISSIONI ALLUNGABILI STANDARD STANDARD EXTENSIBLE TRANSMISSIONS

serie «G»
series (DIN 808)

- Giunti serie "G" con bussole di scorrimento anti-usura.
Joints series "G" with wear resistant sliding bushes.
- Completi di cave per linguetta.
Complete with keyways.
- Ampia gamma di lunghezze per ogni modello.
Wide range of lengths per model.
- Consegna pronta.
Ready delivery.



Mod. Type	Codice / Code	d	D	L2	C	L min.	L max.	corsa stroke	a	b	Albero Shaft	D1	Peso Weight Kg
05GA29	SGOA 1429	14	28	60	14	300	450	150	5	16,3	13 x 16 Z6	29	1,03
05GA32	SGOA 1432	14	28	60	14	350	550	200	5	16,3	13 x 16 Z6	29	1,17
05GA35	SGOA 1435	14	28	60	14	400	650	250	5	16,3	13 x 16 Z6	29	1,33
1GA1	SGOA 1610	16	32	68	16	190	220	30	5	18,3	16 x 20 Z6	32	0,90
1GA15	SGOA 1615	16	32	68	16	210	250	40	5	18,3	16 x 20 Z6	32	0,98
1GA2	SGOA 1620	16	32	68	16	240	320	80	5	18,3	16 x 20 Z6	32	1,10
1GA23	SGOA 1623	16	32	68	16	250	350	100	5	18,3	16 x 20 Z6	32	1,14
1GA26	SGOA 1626	16	32	68	16	275	390	115	5	18,3	16 x 20 Z6	32	1,24
1GA29	SGOA 1629	16	32	68	16	300	430	130	5	18,3	16 x 20 Z6	32	1,33
1GA32	SGOA 1632	16	32	68	16	380	590	210	5	18,3	16 x 20 Z6	32	1,60
1GA35	SGOA 1635	16	32	68	16	400	630	230	5	18,3	16 x 20 Z6	32	1,73
2GA1	SGOA 1810	18	36	74	17	230	280	50	6	20,8	18 x 22 Z6	37	1,35
2GA15	SGOA 1815	18	36	74	17	250	320	70	6	20,8	18 x 22 Z6	37	1,46
2GA18	SGOA 1818	18	36	74	17	270	370	100	6	20,8	18 x 22 Z6	37	1,55
2GA2	SGOA 1820	18	36	74	17	290	400	110	6	20,8	18 x 22 Z6	37	1,66
2GA23	SGOA 1823	18	36	74	17	300	415	115	6	20,8	18 x 22 Z6	37	1,71
2GA26	SGOA 1826	18	36	74	17	400	620	220	6	20,8	18 x 22 Z6	37	2,23